

User Manual

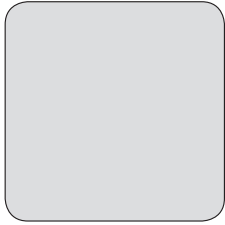

Dishwasher

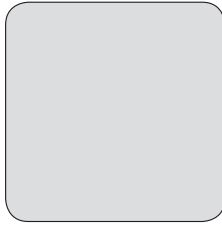
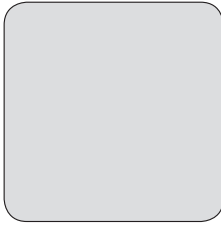
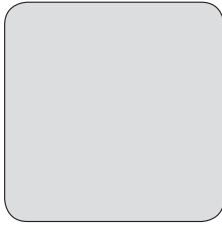
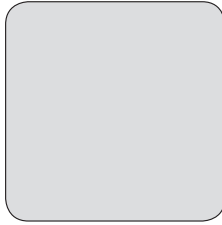
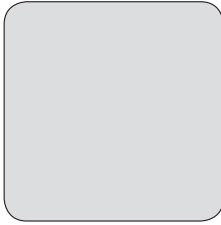

Contents

Safety information.....	2	Hints and tips.....	9
Safety instructions.....	3	Care and cleaning.....	10
Control panel.....	4	Troubleshooting.....	11
Programs.....	5	Technical information.....	12
Before first use.....	5	Warranty.....	12
Daily use.....	6		

Subject to change without notice.

Safety information

Before the installation and use of the appliance, carefully read the supplied instructions. The manufacturer is not responsible if an incorrect installation and use causes injuries and damages. Always keep the instructions with the appliance for future reference.

Children and vulnerable people safety

- This appliance can be used by children aged from 8 years and above and persons with reduced physical, sensory or mental capabilities or lack of experience and knowledge if they have been given supervision or instruction concerning use of the appliance in a safe way and understand the hazards involved.
- Do not let children play with the appliance.
- Keep all detergents away from children.
- Keep children and pets away from the appliance door when it is open.
- Cleaning and user maintenance shall not be made by children without supervision.

General Safety

- This appliance is intended to be used in household and similar applications such as:
 - farm houses; staff kitchen areas in shops, offices and other working environments;
 - by clients in hotels, motels, bed & breakfast and other residential type environments.
- Do not change the specification of this appliance.
- The operating water pressure (minimum and maximum) must be between 0.5 (0.05) / 8 (0.8) bar (kPa)
- Obey the maximum number of 13 place settings.

- If the supply cord is damaged, it must be replaced by the manufacturer, its Authorised Service Centre or a similarly qualified persons in order to avoid a hazard.
- Put knives and cutlery with sharp points in the cutlery basket with the points down or in a horizontal position.
- Do not keep the appliance door open without supervision to prevent to fall on it.
- Before maintenance, deactivate the appliance and disconnect the mains plug from the mains socket.
- Do not use water spray and steam to clean the appliance.
- The appliance is to be connected to the water mains using the new supplied hose-sets. Old hose sets must not be reused.
- The ventilation openings in the base (if applicable) must not be obstructed by a carpet.
- Some dishwasher detergents are strongly alkaline. They can be extremely dangerous if swallowed. Avoid contact with the skin and eyes and keep children away from the dishwasher when the door is open.
- Check that the detergent receptacle is empty after completion of the wash cycle.

Safety instructions

Installation

- Remove all the packaging.
- Do not install or use a damaged appliance.
- Do not install or use the appliance where the temperature is less than 0 °C.
- Obey the installation instruction supplied with the appliance.

Electrical connection



Warning! Risk of fire and electrical shock.

- The appliance must be earthed.
- Make sure that the electrical information on the rating plate agrees with the power supply. If not, contact an electrician.
- Always use a correctly installed shockproof socket.
- Do not use multi-plug adapters and extension cables.
- Make sure not to cause damage to the mains plug and to the mains cable. Should the mains cable need to be replaced, this must be carried out by our Authorised Service Centre.

- Connect the mains plug to the mains socket only at the end of the installation. Make sure that there is access to the mains plug after the installation.
- Do not pull the mains cable to disconnect the appliance. Always pull the mains plug.

Water connection

- Make sure not to cause damage to the water hoses.
- Before you connect the appliance to new pipes or pipes not used for a long time, let the water flow until it is clean.
- The first time you use the appliance, make sure that there is no leakage.
- If the water inlet hose is damaged, immediately disconnect the mains plug from the mains socket. Contact the Authorised Service Centre to replace the water inlet hose.

Use

- Do not sit or stand on the open door.
- Dishwasher detergents are dangerous. Obey the safety instructions on the detergent packaging.

- Do not drink and play with the water in the appliance.
- Do not remove the dishes from the appliance until the programme is completed. There can be detergent on the dishes.
- The appliance can release hot steam if you open the door while a programme operates.
- Do not put flammable products or items that are wet with flammable products in, near or on the appliance.

Service

- Contact the Authorised Service Centre to repair the appliance. We recommend only the use of original spare parts.

- When you contact the Authorised Service Centre, ensure that you have the following information that is available on the rating plate.
Model :
PNC :
Serial Number :

Disposal



Warning! Risk of injury or suffocation.

- Disconnect the appliance from the mains supply.
- Cut off the mains cable and discard it.
- Remove the door catch to prevent children and pets to get closed in the appliance.

Control panel

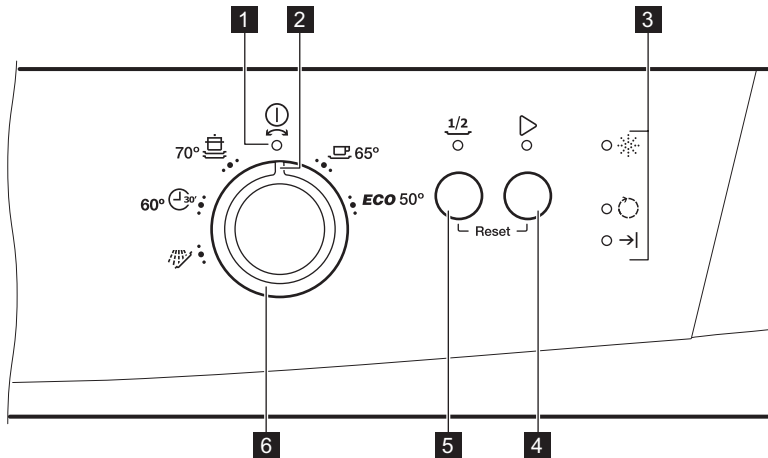

- 1** On/off indicator
- 2** Program marker
- 3** Indicators
- 4** Start button





- 5** Half load button
- 6** Program knob

Indicators

Indicator	Description
	Washing phase. It comes on when the washing phase operates.
	End indicator.

Indicator	Description
	Rinse aid indicator. It is always off while the program operates.
<u>1/2</u>	Half Load indicator.

Programs

Program	Degree of soil Type of load	Program phases	Consumption values 1)		
			Duration (min)	Energy (kWh)	Water (l)
ECO 2)	Normal soil Crockery and cutlery	<ul style="list-style-type: none"> • Prewash • Wash 50 °C • Rinses • Dry 	128	0.75	11.7
	Normal soil Crockery and cutlery	<ul style="list-style-type: none"> • Prewash • Wash 65 °C • Rinses • Dry 	100 - 120	1.2 - 1.4	15 - 16
	Heavy soil Crockery, cutlery, pots and pans	<ul style="list-style-type: none"> • Prewash • Wash 70 °C • Rinses • Dry 	130 - 150	1.3 - 1.5	13 - 15
	Fresh soil Crockery and cutlery	<ul style="list-style-type: none"> • Wash 60 °C • Rinse 	30	0.9	9
	All	<ul style="list-style-type: none"> • Prewash 	14	0.1	4

1) The pressure and the temperature of the water, the variations of the mains supply, the options and the quantity of dishes can change the values.

2) With this program you have the most efficient use of water and energy consumption for crockery and cutlery with normal soil. (This is the standard program for test institutes).

3) With this program you can wash a partial load with fresh soil. It gives good washing results in a short time. It is not recommended to use detergent tablets in the Quick 30 program.

4) Use this program to quickly rinse the dishes. This prevents the remaining food to bond on the dishes and bad odours to come out from the appliance. Do not use detergent with this program.

Information for test institutes

For all the necessary information for test performance, send an email to:

info.test@dishwasher-production.com

Write down the product number (PNC) that is on the rating plate.

Before first use

1. Fill the rinse aid dispenser.

2. Open the water tap.

3. Start a program to remove any processing residuals that can still be inside the appliance. Do not use detergent and do not load the baskets.

Adding rinse aid

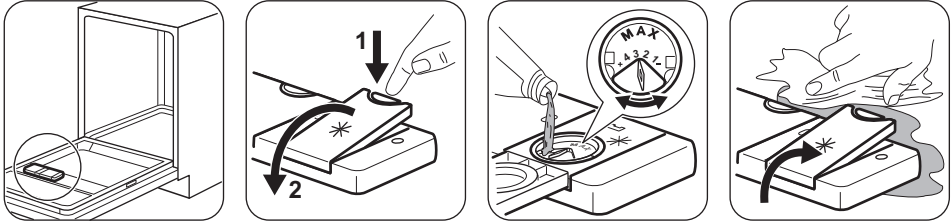

The rinse aid helps to dry the dishes without streaks and stains. It is automatically released during the hot rinse phase.

Daily use

1. Open the water tap.
2. Set the correct program for the type of load and the degree of soil.

Make sure that the appliance is in Program selection mode.

- If the rinse aid indicator is on, fill the rinse aid dispenser.
3. Load the baskets.
 4. Add the detergent.
 5. Start the program.

Adding detergent

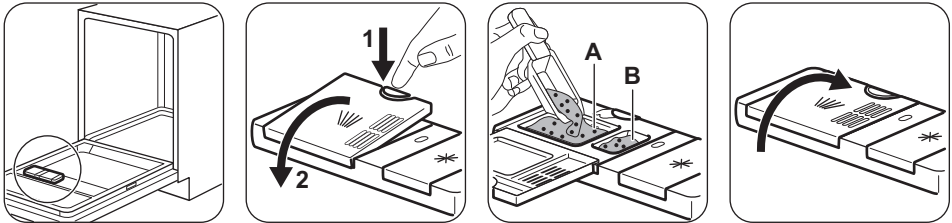

If the program has a prewash phase, put a small quantity of detergent also in compartment B.

Adding multi-tablets

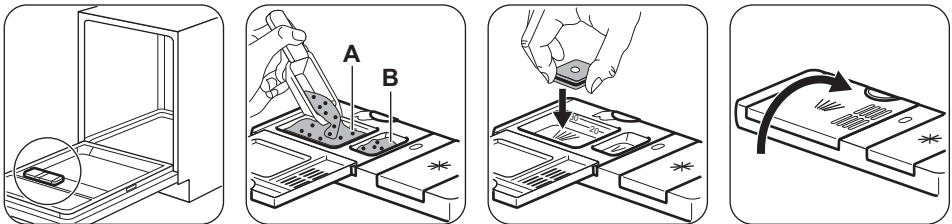

- Set the rinse aid dispenser to the lowest position.

Program selection mode

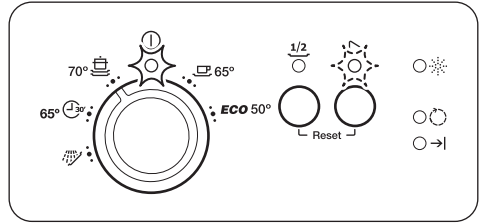
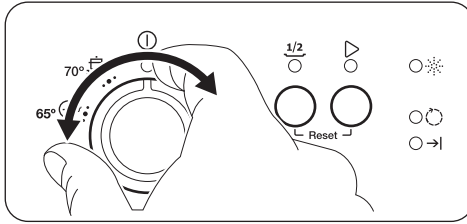

The appliance must be in Program selection mode to start a program. If the control panel does not show this condition, use the Reset function.

Reset

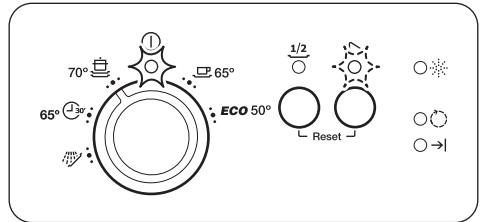
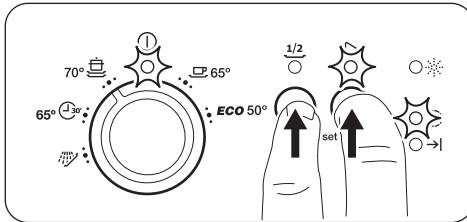

With Reset you can cancel the running program. The appliance goes back to the Program selection mode.

Starting a program

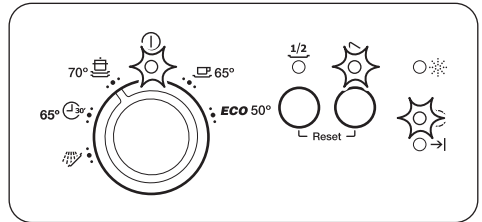
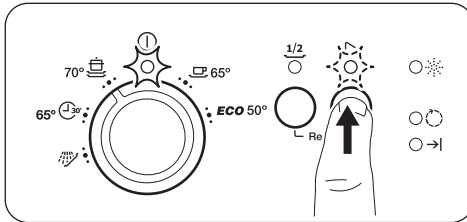
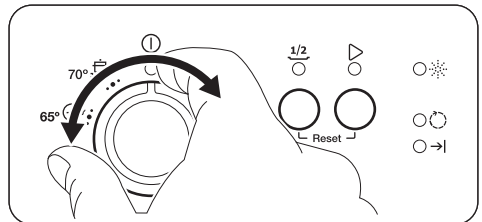
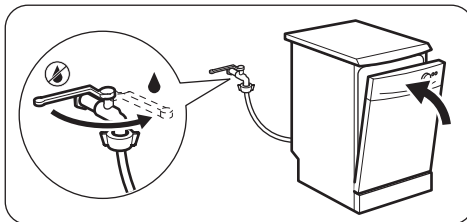

Open the water tap, close the door, select a program, press  .

Option Half load 1/2

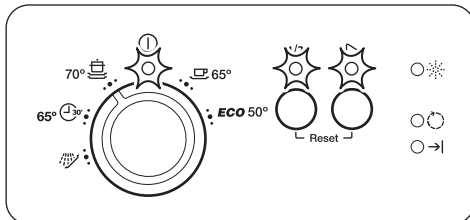
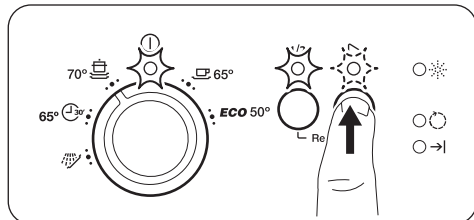
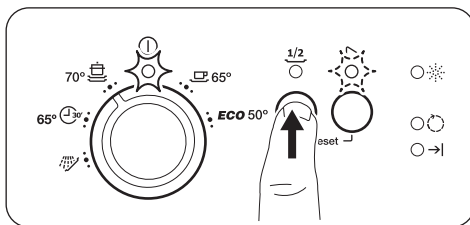
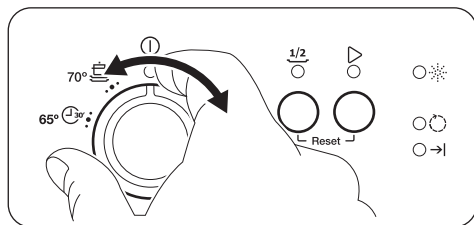

1. Set the program.
2. Press 1/2, the related indicator comes on.
3. Press to start the program.

This option is available with **ECO**, and .

With this option you can wash a small load of tableware and cookware. The option decreases the program duration and the consumption of water and energy. Load both baskets and use less quantity of detergent.

Opening the door while the appliance operates

If you open the door while a program is running, the appliance stops. When you close the door, the appliance continues from the point of interruption.

At the end of the program

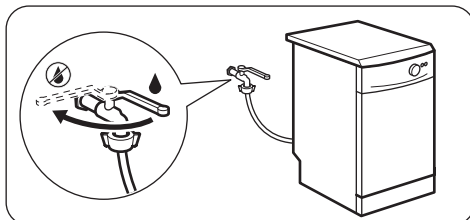
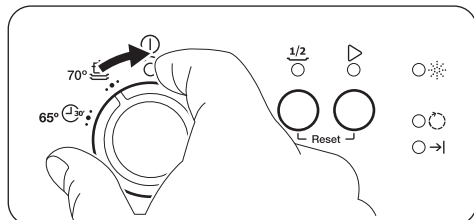
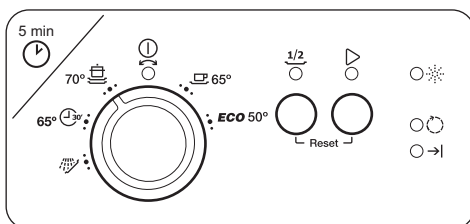
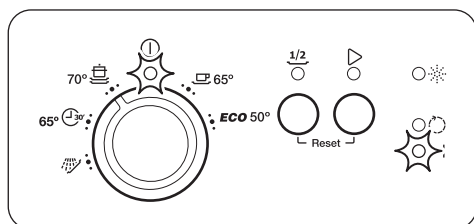

The indicator →**I** comes on. If you do not deactivate the appliance within 5 minutes all indicators goes off. This helps to decrease energy consumption.

Turn the knob to . Close the tap.



For the better drying results keep the appliance door ajar for some minutes before you remove the dishes. Let the dishes cool down before you remove them from the appliance. Hot dishes are easily damaged.

Hints and tips

General

The following hints will ensure optimal cleaning and drying results in daily use and also help to protect the environment.

- Remove larger residues of food from the dishes into the waste bin.
- Do not pre-rinse dishes by hand. When needed, use the prewash program (if available) or select a program with a prewash phase.
- Always use the whole space of the baskets.
- When loading the appliance, make sure that the dishes can be completely reached and washed by the water released from the spray arm nozzles. Make sure that items do not touch or cover each other.
- You can use dishwasher detergent and rinse aid separately or you can use the multi-tablets (e.g. "3in1", "4in1", "All in 1"). Follow the instructions written on the packaging.
- Select the program according to the type of load and degree of soil. With the ECO program you have the most efficient use of water and energy consumption for crockery and cutlery with normal soil.

Using rinse aid and detergent

- Only use rinse aid and detergent for dishwasher. Other products can cause damage to the appliance.
- Detergent tablets do not fully dissolve with short programs. To prevent detergent residues on the tableware, we recommend that you use the tablets with long programs.
- Do not use more than the correct quantity of detergent. Refer to the instructions on the detergent packaging.

What to do if you want to stop using multi-tablets

Before you start to use separately detergent and rinse aid do the following procedure.

1. Make sure that the rinse aid container is full.

2. Start the shortest program with a rinsing phase. Do not add detergent and do not load the baskets.
3. Adjust the released quantity of rinse aid.

Loading the baskets

- Only use the appliance to wash items that are dishwasher-safe.
- Do not put in the appliance items made of wood, horn, aluminium, pewter and copper.
- Do not put in the appliance items that can absorb water (sponges, household cloths).
- Remove remaining food from the items.
- Make soft the remaining burned food on the items.
- Put hollow items (cups, glasses and pans) with the opening down.
- Make sure that cutlery and dishes do not bond together. Mix spoons with other cutlery.
- Make sure that glasses do not touch other glasses.
- Put small items in the cutlery basket.
- Put light items in the upper basket. Make sure that the items do not move.
- Make sure that the spray arm can move freely before you start a program.

Before starting a programme

Make sure that:

- The filters are clean and correctly installed.
- The spray arms are not clogged.
- There is dishwasher rinse aid (unless you use multi-tablets).
- The position of the items in the baskets is correct.
- The programme is applicable for the type of load and for the degree of soil.
- The correct quantity of detergent is used.

Unloading the baskets

1. Let the tableware cool down before you remove it from the appliance. Hot items can be easily damaged.
2. First remove items from the lower basket, then from the upper basket.



At the end of the program water can still remain on the sides and on the door of the appliance.



For the better drying results open the door 5-10 cm and allow tableware to cool down for 30-40 min.

Care and cleaning



Warning! Before maintenance, deactivate the appliance and disconnect the mains plug from the main socket.



Dirty filters and clogged spray arms decrease the washing results. Make a check regularly and, if necessary, clean them.

Cleaning the filters

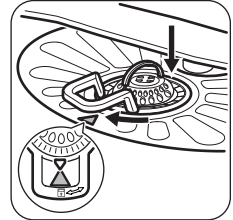
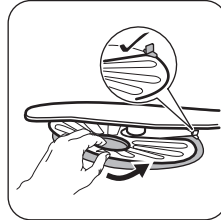
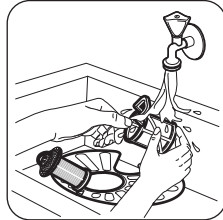
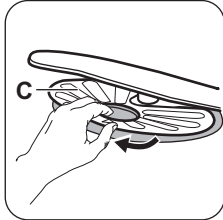
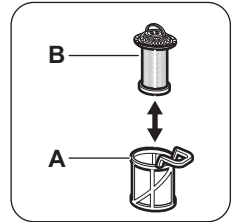
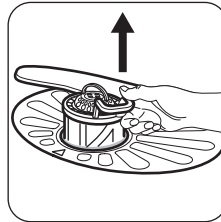
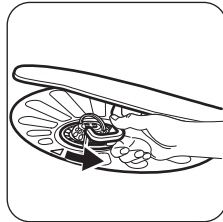
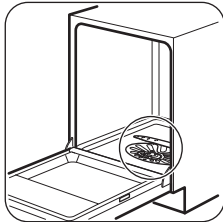

- Make sure that there are no residues of food or soil in or around the edge of the sump.
- Put back in place the flat filter (C). Make sure that it is correctly positioned under the 2 guides.
- Reassemble the filters (A) and (B).
- Put back the filter (A) in the flat filter (C). Turn it clockwise until it locks.



An incorrect position of the filters can cause bad washing results and damage to the appliance

Cleaning the spray arms

Do not remove the spray arms. If the holes in the spray arms are clogged, remove remaining parts of soil with a thin pointed object.

External cleaning

- Clean the appliance with a moist soft cloth.
- Only use neutral detergents.

- Do not use abrasive products, abrasive cleaning pads or solvents.

Internal cleaning







- Carefully clean the appliance, including the rubber gasket of the door, with a soft moist cloth.
- If you regularly use short duration program, these can leave deposits of grease and limescale inside the appliance. To prevent this, we recommend to

run long duration program at least 2 times per month.

Troubleshooting

If the appliance does not start or it stops during operation, before you contact the Service, check if you can solve the problem by yourself with the help of the information in the table.

With some problems different indicators flash intermittently and/or continuously to show an alarm code.

Problem and alarm code	Possible solution
You cannot activate the appliance.	<ul style="list-style-type: none"> • Make sure that the mains plug is connected to the mains socket. • Make sure that there is no a damage fuse in the fuse box.
The program does not start.	<ul style="list-style-type: none"> • Make sure that the appliance door is closed. • Press Start. • The appliance has started the procedure to recharge the resin inside the water softener. The duration of the procedure is approximately 5 minutes.
The appliance does not fill with water. <ul style="list-style-type: none"> • The indicator  flashes 1 time intermittently. • The indicator  flashes continuously. 	<ul style="list-style-type: none"> • Make sure that the water tap is open. • Make sure that the pressure of the water supply is not too low. For this information, contact your local water authority. • Make sure that the water tap is not clogged. • Make sure that the filter in the inlet hose is not clogged. • Make sure that the inlet hose has no kinks or bends.
The appliance does not drain the water. <ul style="list-style-type: none"> • The indicator  flashes 2 times intermittently. • The indicator  flashes continuously. 	<ul style="list-style-type: none"> • Make sure that the sink spigot is not clogged. • Make sure that the drain hose has no kinks or bends.
The anti-flood device is on. <ul style="list-style-type: none"> • The indicator  flashes 3 times intermittently. • The indicator  flashes continuously. 	<ul style="list-style-type: none"> • Close the water tap and contact the Service.

Once you have checked the appliance, press . If the problem occurs again, contact the Service.

For alarm codes not described in the table, contact the Service.

The washing and drying results are not satisfactory

Problem	Possible solution
There are whitish streaks or bluish layers on glasses and dishes.	<ul style="list-style-type: none"> • The release quantity of rinse aid is too much. Adjust the rinse aid selector to a lower position. • The quantity of detergent is too much.
There are stains and dry water drops on glasses and dishes.	<ul style="list-style-type: none"> • The released quantity of rinse aid is not sufficient. Adjust the rinse aid selector to a higher position. • The quality of the rinse aid can be the cause.

Problem	Possible solution
The dishes are wet.	<ul style="list-style-type: none"> The program does not have a drying phase or has a drying phase with low temperature. The rinse aid dispenser is empty. The quality of the rinse aid can be the cause. Keep the dishwasher door ajar for some time before removing tableware.



Refer to "**Hints and tips**" for other possible causes.

Technical information

Dimensions	Width / height / depth (mm)	600 / 850 / 625
Electrical connection ¹⁾	Voltage (V)	220 - 240
	Frequency (Hz)	50
Water supply pressure	Min. / max. bar (MPa)	0.5 (0.05) / 8 (0.8)
Water supply	Cold water or hot water ²⁾	max 60 °C
Capacity	Place settings	13
Power consumption	Left-on mode (W)	5.0
Power consumption	Off-mode (W)	0.50

1) Refer to the rating plate for other values.

2) If the hot water comes from alternative source of energy, (e.g. solar panels, aeolian energy), use the hot water supply to decrease energy consumption.

Rating Plate

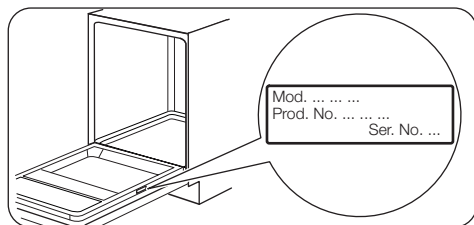

Information for test institutes

For all the necessary information for test performance, send an email to:

info.test@dishwasher-production.com

Write down the product number (PNC) that is on the rating plate.

Warranty

Electrolux

FOR SALES IN AUSTRALIA AND NEW ZEALAND
APPLIANCE: DISHWASHER

This document sets out the terms and conditions of the product warranties for Electrolux Appliances. It is an important document. Please keep it with your

proof of purchase documents in a safe place for future reference should you require service for your Appliance.

- In this warranty:
 - 'acceptable quality' as referred to in clause 10 of this warranty has the same meaning referred to in the ACL;

- b) 'ACL' means Schedule 2 of the Competition and Consumer Act 2010;
 - c) 'Appliance' means any Electrolux product purchased by you and accompanied by this document;
 - d) 'ASC' means Electrolux authorised service centres;
 - e) 'Electrolux' means Electrolux Home Products Pty Ltd of 163 O'Riordan Street, Mascot NSW 2020, ABN 51 004 762 341 in respect of Appliances purchased in Australia and Electrolux (NZ) Limited (collectively 'Electrolux') of 3-5 Niall Burgess Road, Mount Wellington, in respect of Appliances purchased in New Zealand;
 - f) 'major failure' as referred to in clause 10 of this warranty has the same meaning referred to in the ACL and includes a situation when an Appliance cannot be repaired or it is uneconomic for Electrolux, at its discretion, to repair an Appliance during the Warranty Period;
 - g) 'Warranty Period' means the Appliance is warranted against manufacturing defects in Australia for 24 months and in New Zealand for 24 months, following the date of original purchase of the Appliance;
 - h) 'you' means the purchaser of the Appliance not having purchased the Appliance for resale, and 'your' has a corresponding meaning.
2. This warranty only applies to Appliances purchased and used in Australia or New Zealand and used in normal domestic applications and is in addition to (and does not exclude, restrict, or modify in any way) any non-excludable statutory warranties in Australia or New Zealand.
 3. During the Warranty Period Electrolux or its ASC will, at no extra charge if your Appliance is readily accessible for service, without special equipment and subject to these terms and conditions, repair or replace any parts which it considers to be defective. Electrolux or its ASC may use remanufactured parts to repair your Appliance. You agree that any replaced Appliances or parts become the property of Electrolux. This warranty does not apply to light globes, batteries, filters or similar perishable parts.
 4. Parts and Appliances not supplied by Electrolux are not covered by this warranty.
 5. To the extent permitted by law, you will bear the cost of transportation, travel and delivery of the Appliance to and from Electrolux or its ASC. If you reside outside of the service area, you will bear the cost of:
 - a) travel of an authorised representative;
 - b) transportation and delivery of the Appliance to and from Electrolux or its ASC.
- In all instances, unless the Appliance is transported by Electrolux or an Electrolux authorised representative, the Appliance is transported at the owner's cost and risk while in transit to and from Electrolux or its ASC.
6. Proof of purchase is required before you can make a claim under this warranty.
 7. You may not make a claim under this warranty unless the defect claimed is due to faulty or defective parts or workmanship. Electrolux is not liable in the following situations (which are not exhaustive):
 - a) the Appliance is damaged by:
 - accident
 - misuse or abuse, including failure to properly maintain or service
 - normal wear and tear
 - power surges, electrical storm damage or incorrect power supply
 - incomplete or improper installation
 - incorrect, improper or inappropriate operation
 - insect or vermin infestation
 - failure to comply with any additional instructions supplied with the Appliance;
 - b) the Appliance is modified without authority from Electrolux in writing;
 - c) the Appliance's serial number or warranty seal has been removed or defaced;
 - d) the Appliance was serviced or repaired by anyone other than Electrolux, an authorised repairer or ASC.
 8. This warranty, the contract to which it relates and the relationship between you and Electrolux are governed by the law applicable where the Appliance was purchased. Where the Appliance was purchased in New Zealand for commercial purposes the Consumer Guarantee Act does not apply.
 9. To the extent permitted by law and subject to your non-excludable statutory rights and warranties, Electrolux excludes all warranties and liabilities (other than as contained in this document) including liability for any loss or damage whether direct or indirect arising from your purchase, use or non use of the Appliance.
 10. For Appliances and services provided by Electrolux in Australia, the Appliances come with a guarantee by Electrolux that cannot be excluded under the ACL. You are entitled to a replacement or refund for a major failure and for compensation for any other reasonably foreseeable loss or damage. You are also entitled to have the Appliance repaired or

- replaced if the Appliance fails to be of acceptable quality and the failure does not amount to a major failure. The benefits to you given by this warranty are in addition to your other rights and remedies under a law in relation to the Appliances or services to which the warranty relates.
11. At all times during the Warranty Period, Electrolux shall, at its discretion, determine whether repair, replacement or refund will apply if an Appliance has a valid warranty claim applicable to it.
 12. For Appliances and services provided by Electrolux in New Zealand, the Appliances come with a guarantee by Electrolux pursuant to the provisions of the Consumer Guarantees Act, the Sale of Goods Act and the Fair Trading Act.
13. To enquire about claiming under this warranty, please follow these steps:
 - a) carefully check the operating instructions, user manual and the terms of this warranty;
 - b) have the model and serial number of the Appliance available;
 - c) have the proof of purchase (e.g. an invoice) available;
 - d) telephone the numbers shown below.
 14. You accept that if you make a warranty claim, Electrolux and its ASC may exchange information in relation to you to enable Electrolux to meet its obligations under this warranty.

Important Notice

Before calling for service, please ensure that the steps listed in clause 13 above have been followed.

FOR SERVICE

or to find the address of your nearest state service centre in Australia
Please call 13 13 4 9

For the cost of a local call (Australia only)

SERVICE AUSTRALIA

 **Electrolux**
 ELECTROLUX HOME PRODUCTS
www.electrolux.com.au

FOR SPARE PARTS

or to find the address of your nearest state spare parts centre in Australia
Please call 13 13 50

For the cost of a local call (Australia only)

FOR SERVICE

or to find the address of your nearest authorised service centre in New Zealand
Free call 0800 10 66 10

(New Zealand only)

SERVICE NEW ZEALAND

 **Electrolux**
 ELECTROLUX (NZ) Limited
www.electrolux.co.nz

FOR SPARE PARTS

or to find the address of your nearest state spare parts centre in New Zealand
Free call 0800 10 66 20

(New Zealand only)

ENVIRONMENT CONCERNS

Recycle the materials with the symbol . Put the packaging in applicable containers to recycle it. Help protect the environment and human health and to recycle waste of electrical and electronic appliances. Do

not dispose appliances marked with the symbol  with the household waste. Return the product to your local recycling facility or contact your municipal office.

www.dishlex.com.au